

# ecorail®

KORKULUK SİSTEMLERİ / RAILING SYSTEMS

PRATİK VE EKONOMİK KORKULUK SİSTEMLERİ  
PRATIC & ECONOMIC RAILING SYSTEMS

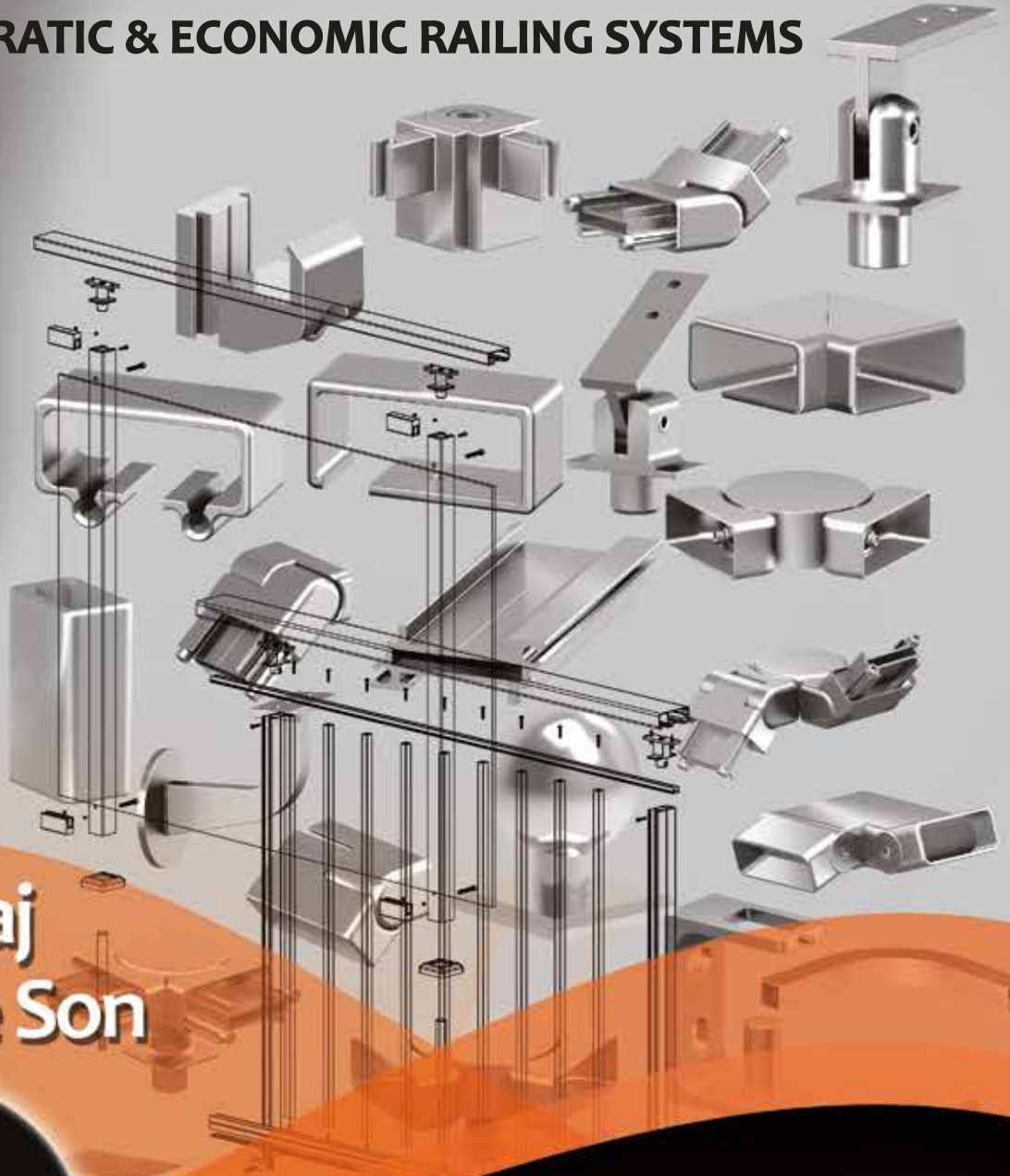

Ankraj  
Delmeye Son

2015

No More  
Anchor Drilling

Ürün Kataloğu  
Product Catalogue

# ecorail®

KORKULUK SİSTEMLERİ / RAILING SYSTEMS

## İÇİNDEKİLER / INDEX

PROFİLLER PROFILES	1
UYGULAMALAR 1 APPLICATIONS 1	3
MAFSALLAR SADDLES	4
UYGULAMALAR 2 APPLICATIONS 2	5

TAPALAR ENDCAPS	6
CAM TUTUCULAR GLASSHOLDERS	6
UYGULAMALAR 3 APPLICATIONS 3	7
YAN BAĞLANTI PAPUÇLARI SIDE INSTALLATION BRACKETS	8

FLANŞLAR FLANGES	9
DİRSEKLER ELBOWS	10
BAĞLANTI VE BİLEZİKLER JOINTERS & RINGS	12
YARDIMCI MALZEMELER AUXILIARIES	13

## KATALOG KULLANIMI HAKKINDA / ABOUT USAGE OF CATALOGUE

Ürün görsellerinin üst ve alt köşelerinde çeşitli ifadeler yer almaktadır. Aşağıdaki örneklere bu ifadelerin açıklamaları yapılmıştır.

### ÖRNEK 1: [EM 211](#)

Üst köşede yer alan kodlar bu aksesuarımızın kullanılabileceği küpeşte profillerini, alt köşede yer alan kodlar ise dikme profillerini göstermektedir.

### ÖRNEK 2: [ES 123C](#)

Üst köşede yer alan kodlar bu aksesuarımızın kullanılabileceği küpeşte profillerini, alt köşede yer alan ifadeler ise açılış imkanlarını göstermektedir.



There are various expressions on upper and bottom corners of images of product. These expressions are explained in the following examples.

### EXAMPLE 1: [EM 211](#)

The codes at the upper corner show the balustrade profiles and the codes at the bottom corner show the post profiles with which this accessory can be used.

### EXAMPLE 2: [ES 123C](#)

The codes at the upper corner show the balustrade profiles which can be used with this accessory and the angles at the bottom corner defines the angle abilities of this accessory.

Geliştirdiğimiz tüm ürünler tasarım tescil ve faydalı model belgeleri ile koruma altındadır. Ürünlerimizden ve katalogta bulunan görsellerimizden alıntı yapıldığı takdirde şirketimizce maddi ve manevi tazminat davasına konu edileceğini bilgilerinize sunarız.

Anlayış ve işbirliğiniz için teşekkür ederiz.

All of the profiles and accessories developed by our company are patented. Please note that pictures and drawings in this catalogue can not be used without our permission.

GÜRSAN ALÜMİNYUM bildirmeksizin değişiklik yapma hakkını saklı tutar. We reserve the right to change the specifications without notice.

# ecorail®

KORKULUK SİSTEMLERİ / RAILING SYSTEMS

... bir **GÜRSAN ALÜMİNYUM** markasıdır.  
... is a trademark of **GÜRSAN ALUMİNYUM**

**KÜPEŞTE PROFİLLERİ / HANDRAIL PROFILES**

**EP 111**

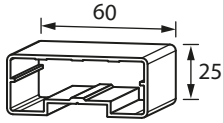

0.780 kg/mt

**EP 112**

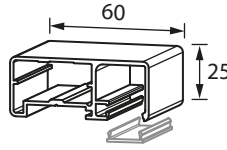

0.850 kg/mt

**EP 113**

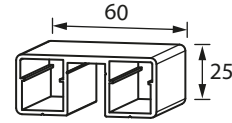

1.060 kg/mt

**EP 121**

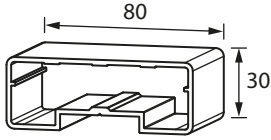

1.310 kg/mt

**EP 122**

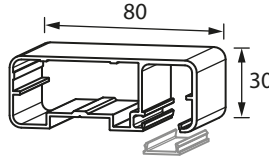

1.110 kg/mt

**EP 123**

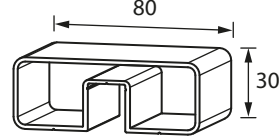

1.230 kg/mt

**DİKME PROFİLLERİ / POST PROFILES**

**EP 201**

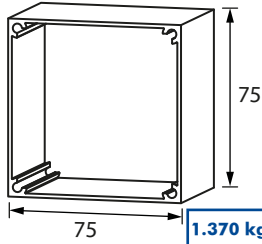

1.370 kg/mt

**EP 211**

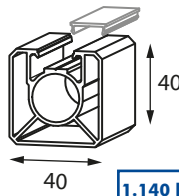

1.140 kg/mt

**EP 212**

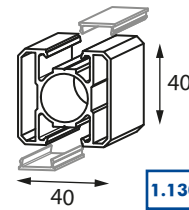

1.130 kg/mt

**EP 213**

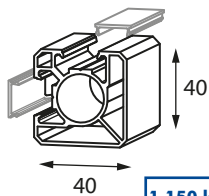

1.150 kg/mt

**EP 221**

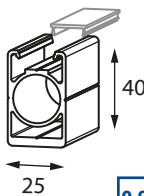

0.900 kg/mt

**EP 231**

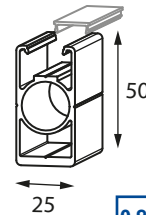

0.990 kg/mt

**PANEL PROFİLLERİ / PANEL PROFILES**

**EP 311**

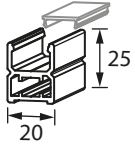

0.470 kg/mt

**EP 311.120**

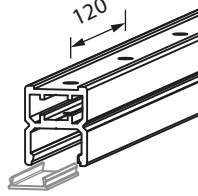

**EP 321**

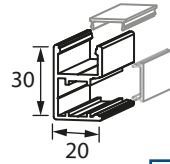

0.440 kg/mt

**EP 331**

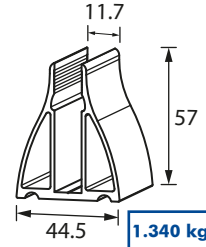

1.340 kg/mt

**YATAY VE DÜŞEY EMNİYET PROFİLLERİ / HORIZONTAL & VERTICAL INFILL PROFILES**

**EP 411**

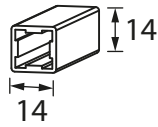

0.215 kg/mt

**EP 412** 11,552

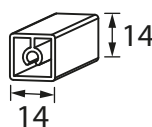

0.220 kg/mt

**EP 422**

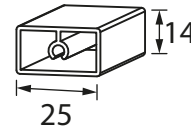

0.300 kg/mt

**KAPAK PROFİLLERİ / CLOSER PROFILES**

**EP 001**

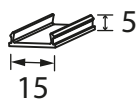

0.062 kg/mt

**EP 002**

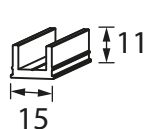

0.220 kg/mt

**EP 002.120**

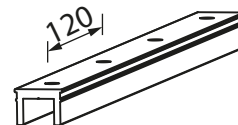

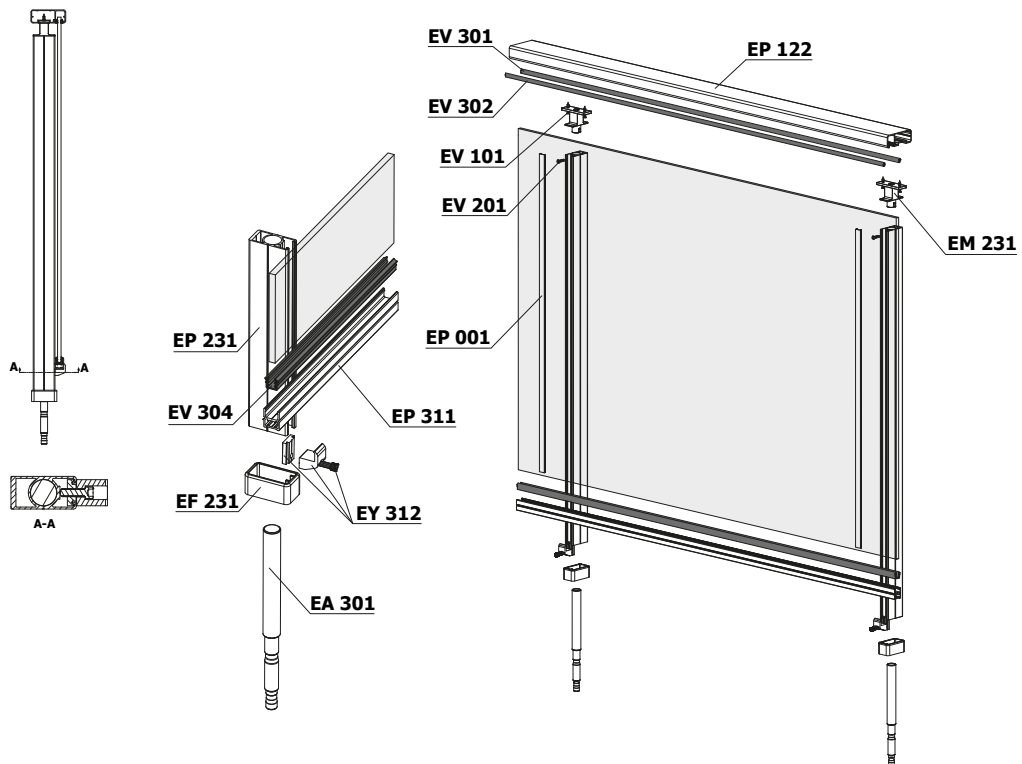
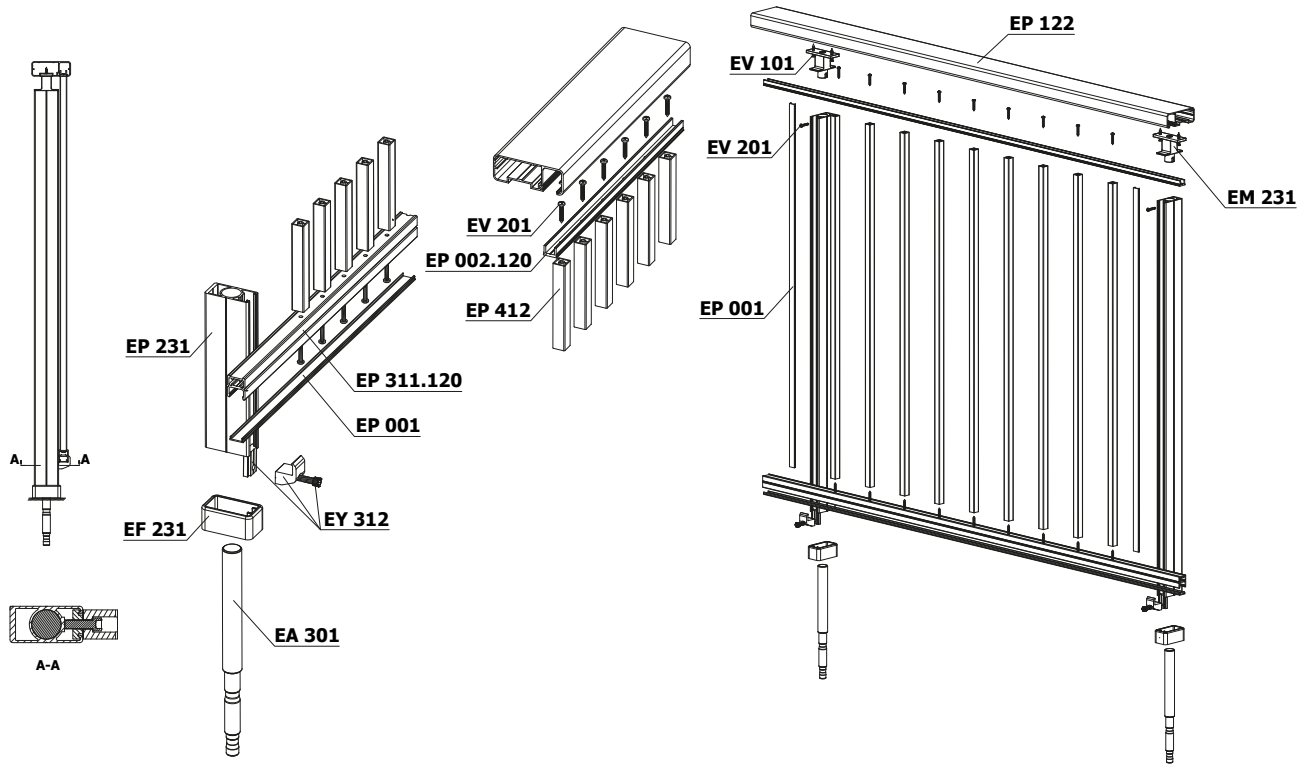

**EM 111**

EP 111  
EP 121



**EM 112**

EP 111  
EP 121



**EM 211**

EP 111  
EP 112  
EP 121  
EP 122



EP 211  
EP 212  
EP 213

**EM 212**

EP 111  
EP 121



EP 211  
EP 212  
EP 213

**EM 213**

EP 111  
EP 121



EP 211  
EP 212  
EP 213

**EM 214**

EP 111  
EP 112



EP 211  
EP 212  
EP 213

**EM 214A**

EP 111



EP 211  
EP 212  
EP 213

**EM 215**

EP 121  
EP 122

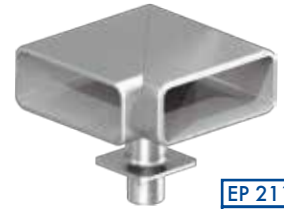

EP 211  
EP 212  
EP 213

**EM 215A**

EP 121  
EP 122



EP 211  
EP 212  
EP 213

**EM 221**

EP 111  
EP 112  
EP 121  
EP 122



EP 221

**EM 222**

EP 111  
EP 121



EP 221

**EM 231**

EP 111  
EP 112  
EP 121  
EP 122



EP 231

**EM 232**

EP 111  
EP 121



EP 231

**EM 233**

EP 113  
EP 123



EP 231

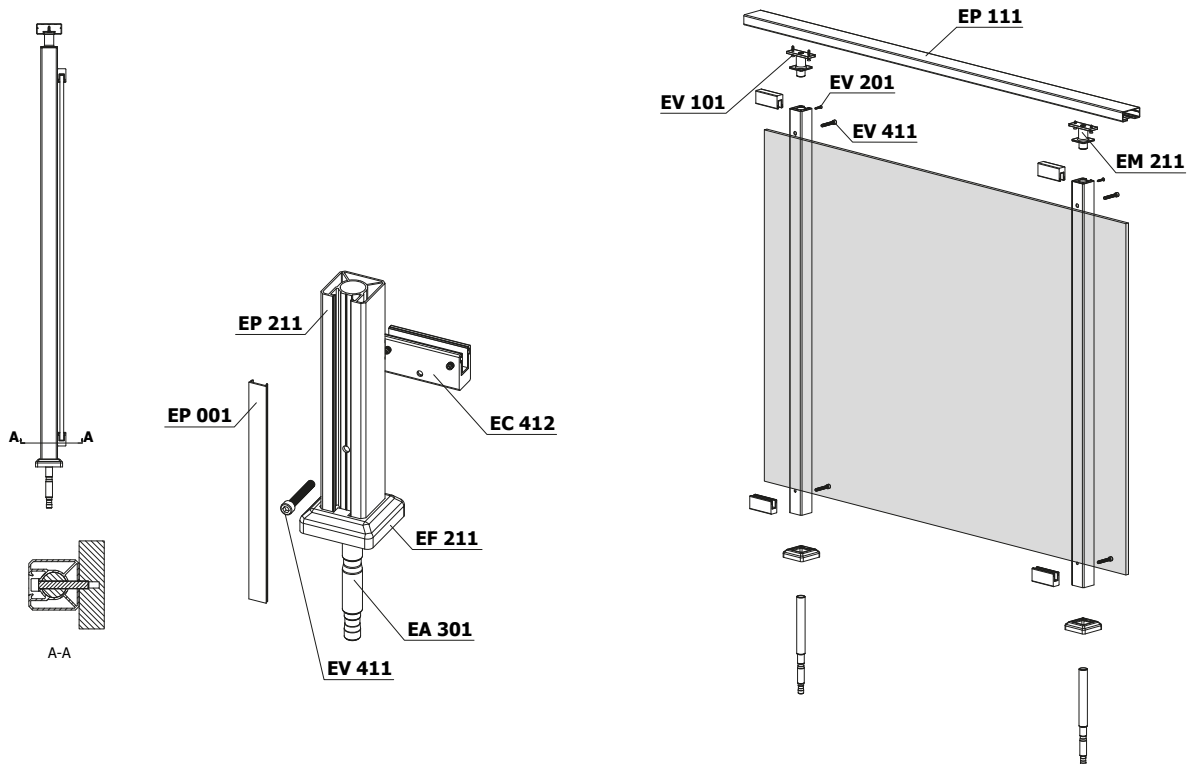
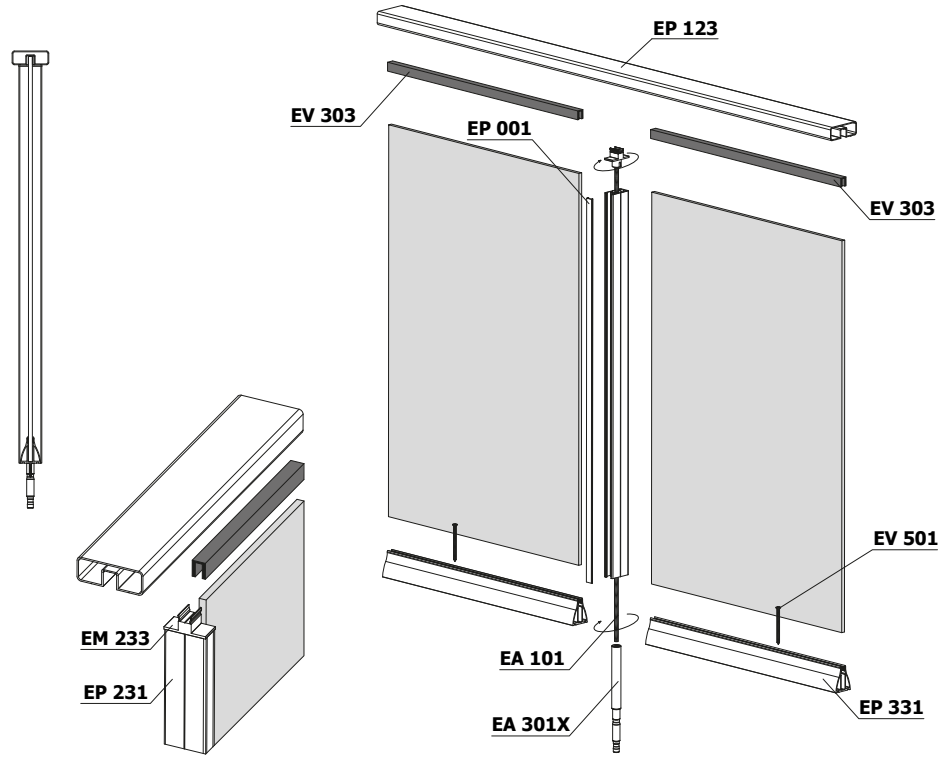



**TAPALAR / ENDCAPS**

**ET 111**

EP 111  
EP 112



**ET 113**

EP 113



**ET 121**

EP 121  
EP 122  
EP 123



**ET 201**



EP 201

**ET 211**



EP 211  
EP 212  
EP 213

**ET 221**



EP 221

**ET 231**



EP 231

**ET 311**



EP 311

**ET 321**



EP 321

**ET 411**



EP 411

**CAM TUTUCULAR / GLASSHOLDERS**

**EC 411A**



EP 211  
EP 212  
EP 213

**EC 411B**



EP 211  
EP 212  
EP 213

**EC 412**



EP 211  
EP 212  
EP 213  
EP 221  
EP 231

**EC 413**



EP 211  
EP 212  
EP 213  
EP 221  
EP 231



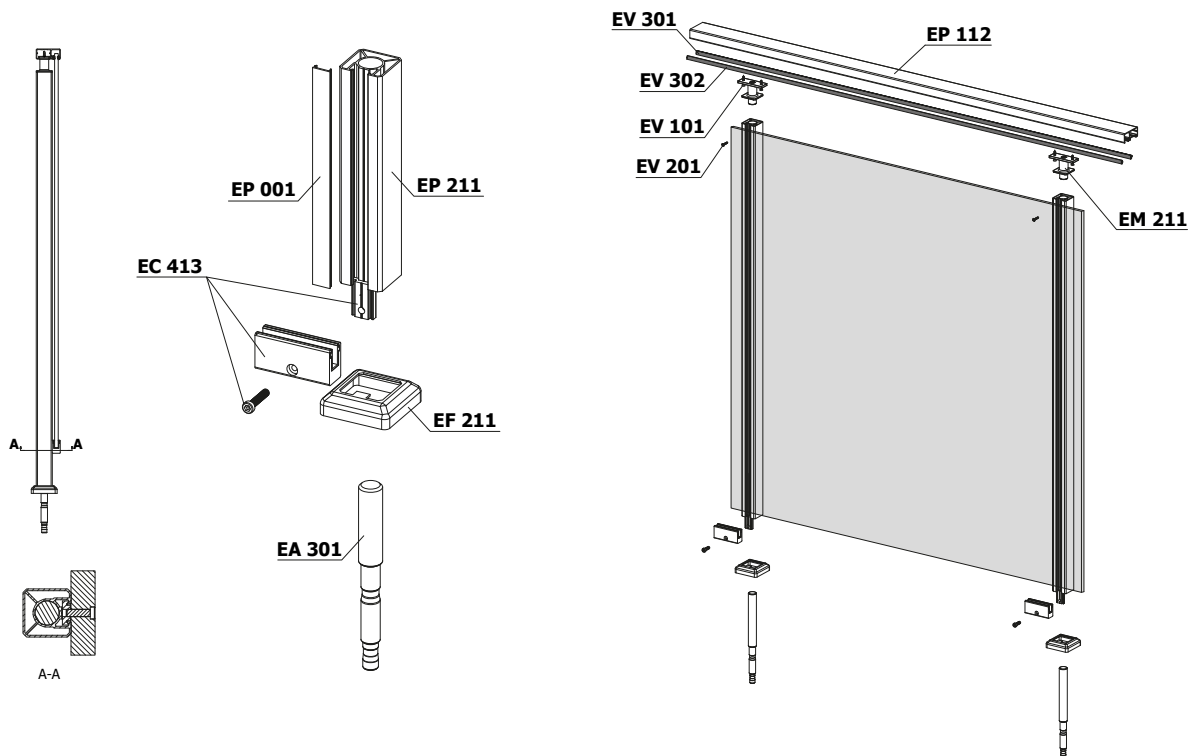
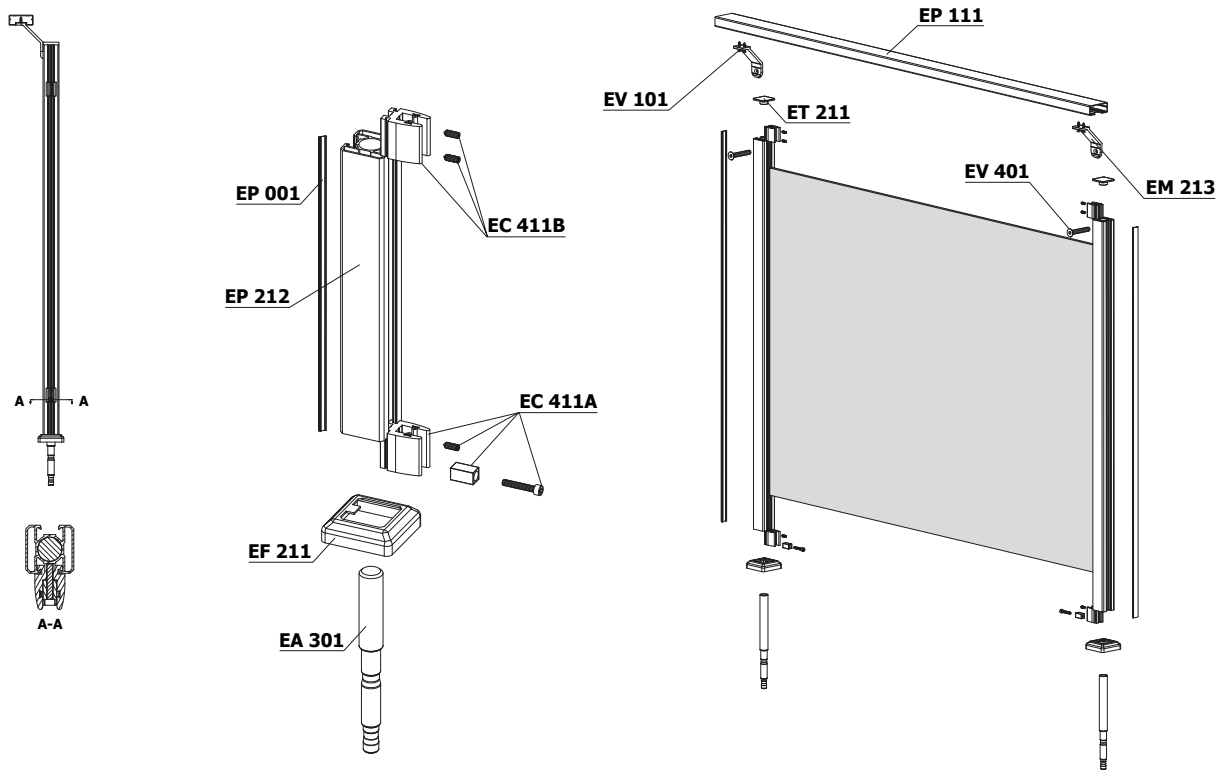

**EY 211**



EP 211  
EP 212  
EP 213

**EY 211A**



EP 211  
EP 212  
EP 213

**EY 211B**

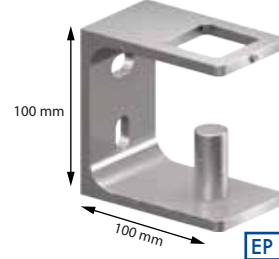

EP 211  
EP 212  
EP 213

**EY 221**

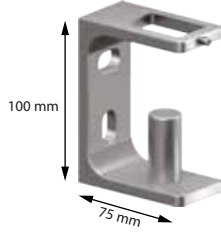

EP 221

**EY 221A**



EP 221

**EY 221B**

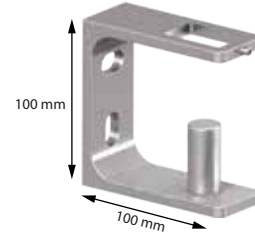

EP 221

**EY 231**



EP 231

**EY 231A**



EP 231

**EY 231B**

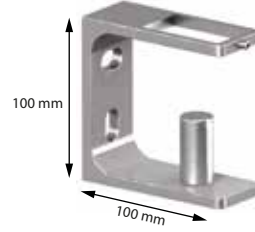

EP 231

**EY 311**

EP 311



EP 211  
EP 212  
EP 213  
EP 221  
EP 231

**EY 312**

EP 311



EP 211  
EP 212  
EP 213  
EP 221  
EP 231

**EY 411**

EP 411



EP 211  
EP 212  
EP 213  
EP 221  
EP 231

**EF 111**

EP 111  
EP 112  
EP 113



**EF 112**

EP 111



0-40°

**EF 113**

EP 113



**EF 121**

EP 121  
EP 122  
EP 123



**EF 122**

EP 121



0-40°

**EF 123**

EP 123



**EF 201**

EP 201



**EF 211**

EP 211  
EP 212  
EP 213



**EF 212**

EP 211  
EP 212  
EP 213



**EF 221**

EP 221



**EF 222**

EP 221



**EF 231**

EP 231



**EF 232**

EP 231



**ES 111**

EP 111  
EP 112



90°

**ES 111A**

EP 113



90°

**ES 111B**

EP 112



90°

**ES 111C**

EP 112



90°

**ES 112**

EP 111  
EP 112



45°

**ES 112A**

EP 113



45°

**ES 112B**

EP 112



45°

**ES 112C**

EP 112



45°

**ES 113**

EP 111



0-90°

**ES 113A**

EP 111



0-40°

**ES 113B**

EP 111



0-90°+0-40°

**ES 113C**

EP 111



0-40°+0-90°+0-40°

**ES 121**

EP 121  
EP 122



90°

**ES 121A**

EP 123



90°

**ES 121B**

EP 122



90°

**ES 121C**

EP 122



90°

**ES 122**

EP 121  
EP 122

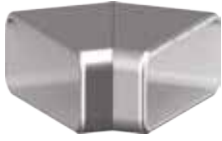

45°

**ES 122A**

EP 123

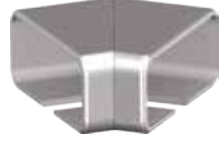

45°

**ES 122B**

EP 122

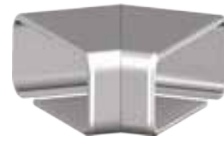

45°

**ES 122C**

EP 122



45°

**ES 123**

EP 121  
EP 122



0-90°

**ES 123A**

EP 121



0-40°

**ES 123BL**

EP 121

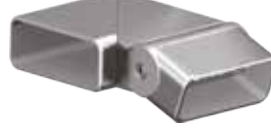

90+0-40°

**ES 123BR**

EP 121



0-40°+90°

**ES 123C**

EP 121



0-40°+90°+0-40°

**ES 311**

EP 311



0-90°

**ES 321**

EP 321



0-90°

**ES 411**

EP 411



90°

**ES 412**

EP 411



45°

**ES 412A**

EP 411



30°

**ES 413**

EP 411



0-90°

**ES 413A**

EP 411



90°+0-90°

**EB 111**

EP 111  
EP 112



**EB 111A**

EP 113



**EB 111B**

EP 112



**EB 112**

EP 111



**EB 113**

EP 111  
EP 112  
EP 121  
EP 122



**EB 121**

EP 121  
EP 122



**EB 121A**

EP 123



**EB 121B**

EP 122



**EB 312**

EP 311

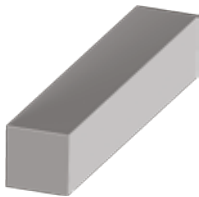

**EB 322**

EP 321

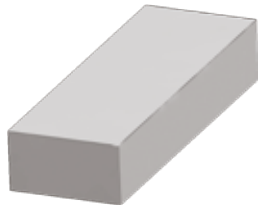

**EB 411**

EP 411



**EB 412**

EP 411

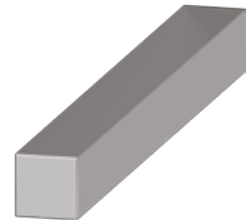

**FİTİLLER / GASKETS**

**EV 301**



**EV 302**



**EV 303**

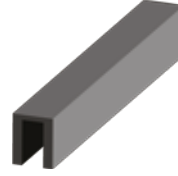



**EV 304**



**VIDALAR VE YAPIŞTIRICILAR / SCREWS AND GLUES**

**VIDALAR / SECREWS**

	EV 101	YHB 4,2x19
	EV 102	YHB 4,2x38
	EV 103	YHB 4,2x45
	EV 201	YSB 4,2X19
	EV 202	YSB 4,2X25
	EV 203	YSB 4.2X38
	EV 204	YSB 4.2X45

**PASLANMAZ İMBUS CIVATALAR  
HEXAGONAL SOCKET SCREWS**

	EV 401	M6x40
	EV 411	M6x40
	EV 412	M6x45
	EV 413	M6x50

**BULDEKS VİDA / BULDEX SCREW**

	EV 501	7,5x100
--	--------	---------

**EV 601**



**EV 602**



**EV 603**



**ANKRAJLAR / ANCHORS**



**SAPLAMALAR / RODS**



EA 101	M8x140
EA 102	M8x1000
EA 103	M10x1250
EA 104	M10x150

**ANKRAJLAR / ANCHORS**

KOD CODE	Ø (mm)	L (mm)
EA 301	20	350
EA 301X*	20	350
EA 301A	20	230
EA 301B	20	200
EA 301D	20	140
EA 301E**	20	220

\*Üst kısım M8 dişli  
\*With M8 thread on top  
\*\*Borudan mamüldür  
\*\*Produced from pipe

**SOMUNLAR / NUTS**

	EA 201	M8 Somun M8 Nut
	EA 202	M10 Somun M10 Nut
	EA 206	M10 Kör Somun M10 Blind Nut

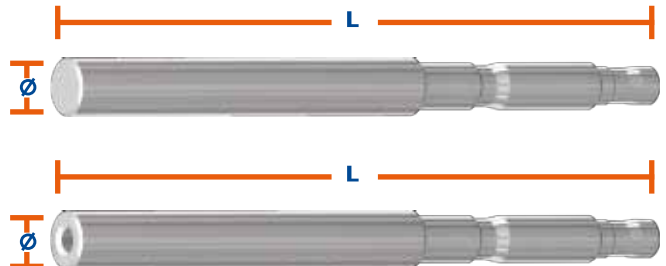



# ecorail®

KORKULUK SİSTEMLERİ / RAILING SYSTEMS

 **GÜRSAN®**

ALÜMİNYUM İMALAT SANAYİ LTD. ŞTİ.

ALKOP San. Sit. B-7 Blok, No:15 Esenyurt / İstanbul / Türkiye  
Tel: +90 212 858 01 61 Faks: +90 212 858 01 65

[www.ecorail.com.tr](http://www.ecorail.com.tr)

